

Pumpkii Model BQ70

Pet Companion Robot

User Manual V3.0

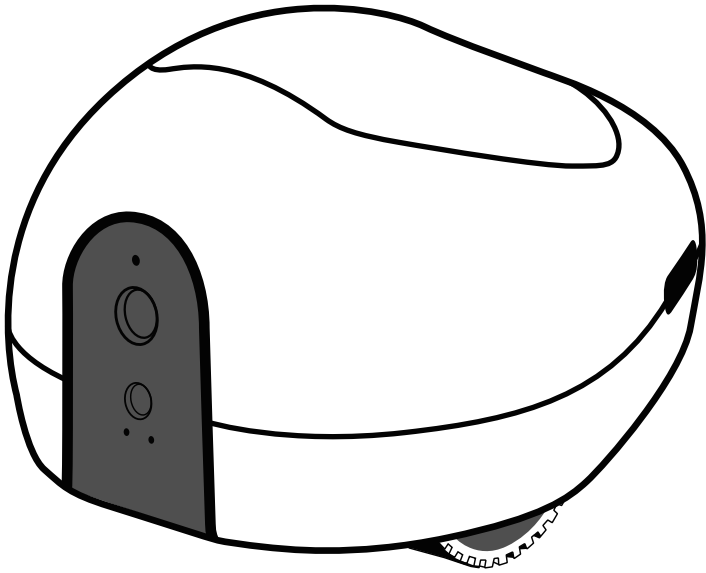

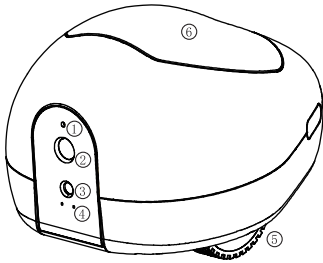

Front

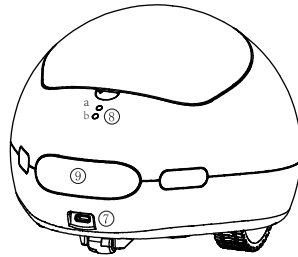

Back

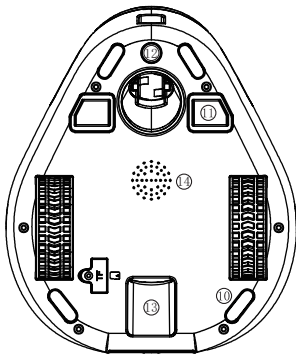

Bottom

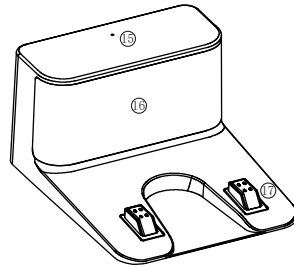

Charging Dock

1. Red Dot Toy
2. HD 1080P Video Camera
3. Night Vision
4. Mic
5. Wheels
6. Snack Cover
7. Type-C Charging Port
8. Indicating Light
 - a: Blinking red light: search for Wi-Fi signal;
 - Blue light on: device connected to router
 - b: Charging Indicator (Red: charging; Blue: full charged)
 - Blinking red light: The battery level is lower than 20%
9. Infrared Sensing Device
10. Sensor X 4
11. Electro-touch Plate X 2vv
12. Turn On/Off Switch
 - Press and hold for 2s to turn on/off with audio prompts
 - Press and hold for 10 s to restore factory settings according to the audio prompts
13. Snack Feeder
14. Speaker
15. Charging Indicator
16. Infrared Emission Module
17. Charging Contact Plate

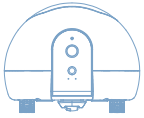

Pumpkii



Charging Dock



Type-C Cable



Quick Guide

1. Install the App

Download the 'PumPlus' app by scanning the QR code.



iOS users can download 'PumPlus' from the App Store, and Android users from the mobile app store.

2. Sign In

Register an account using your email, then log in to 'PumPlus' (check the spam box if you have trouble receiving the conformation code). Click 'Add device' and follow the prompts to complete the initial pairing of your device.

Note: In the settings, grant 'PumPlus' access to Local Network, Camera, Mic and Location (Location permission is used only during the initial WiFi setup) and enable Wireless Data usage for WLAN and Cellular Data (See Q&A for more details).

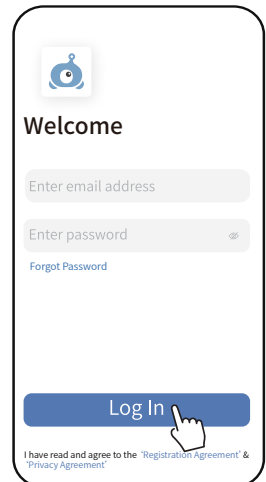
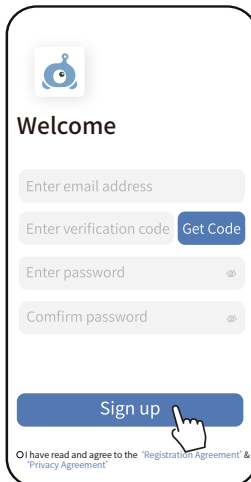
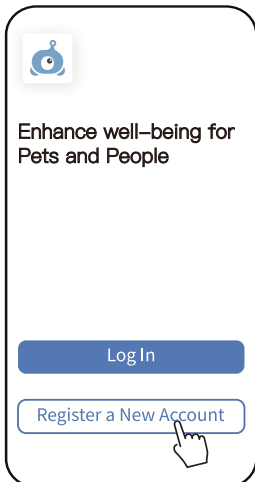

Tip: Before pairing, ensure device is in initial state (press and hold the power button for 2 seconds to turn it on, and after about 10 seconds, you'll hear 'beep... beep... beep'). If not, please reset your device (press and hold the power button for about 10 seconds until you hear 'restoring factory settings,' then release, and the reset is complete).

3. Connect to a 2.4G Wi-Fi Network

Note: When connecting device, ensure that your phone is connected to a 2.4GHz or 2.4GHz/5GHz Wi-Fi network. (See Q&A for more details)

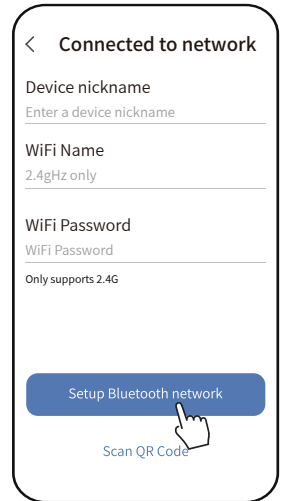

After connecting, a voice prompt will confirm, and you can control your device now.

4. Connect device with QR code

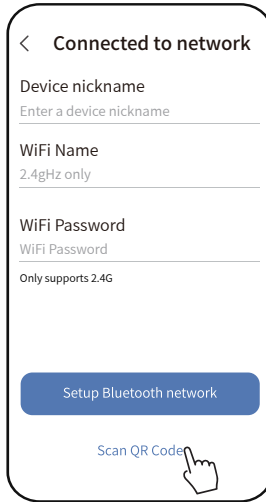

Hold the generated QR code about 15cm from the camera of the device. Wait for the beep after a successful scan, then click 'Next'.

5. The Interface

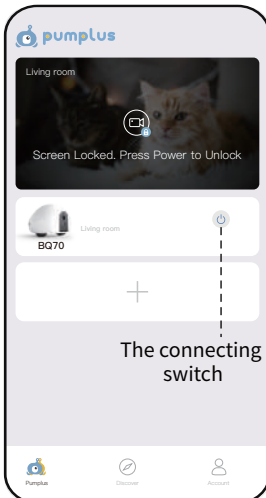

Installation guide

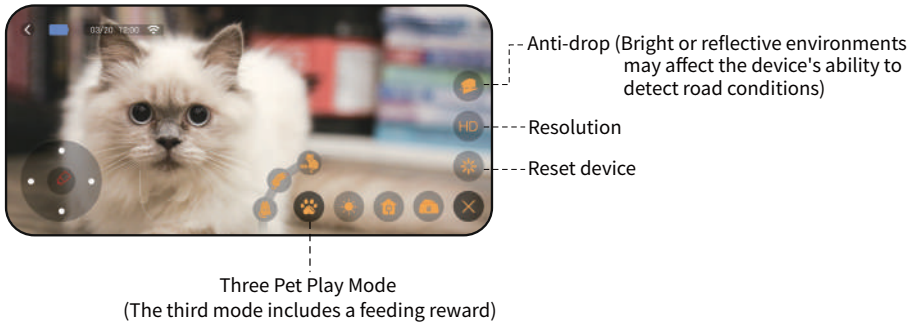
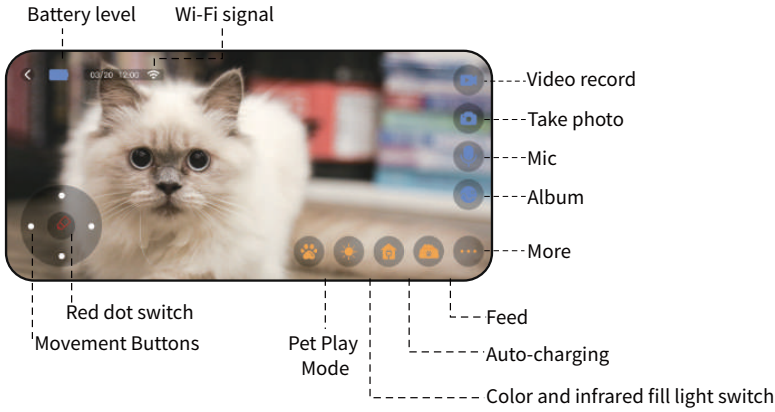

6. Three Pet Play Mode

a. Three pet play mode (activate with the button shown below)

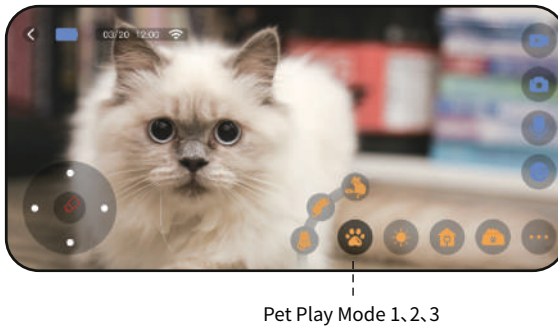

b. Three pet play mode activate the 'red dot' and interact with your pet for 1-2 minutes while moving.

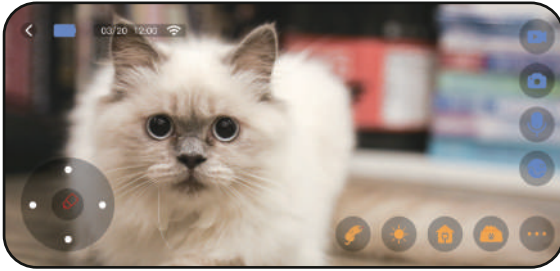

c. Mode 3 is unique—after interacting with your pet, the device will give a treat reward (place your pet's favorite treat in the treat compartment)

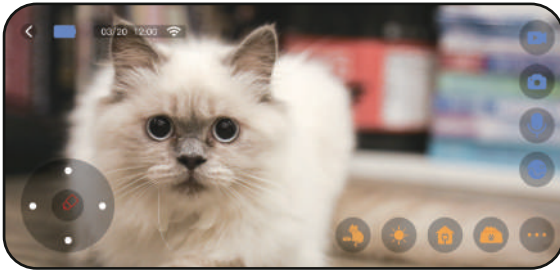

Note: For the best pet entertainment experience, ensure the device is used in an open area within a 2-meter radius. This prevents interference from surrounding objects, allowing the device to move freely and fully engage with your pet.

7. Load Treats

Place your pet's favorite treats in the treat compartment. (The treat compartment is made from food-grade ABS material, so you can use it with confidence.)

Note: Load dry food only, as wet food is not suitable. The treat dispenser is designed to accommodate treats with sizes ranging from 0.2X0.2 to 0.6X0.6 inches.

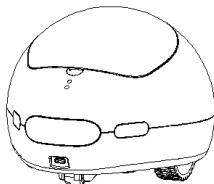

Open

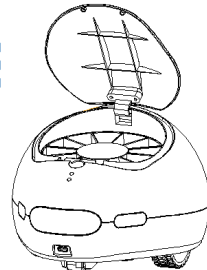

Close

8. Auto-Charging

The device supports short-distance auto-charging. To ensure optimal performance, set the charging dock near a wall; drive the device within a 3-meter range and tap the 'auto-charging' icon on 'PumPlus' app interface, it will easily return to the dock.

Tips:

- a. When starting to recharge, the device will circle a small area to locate the charging dock. If the signal isn't detected, the app will notify you to drive the device closer to the dock.
- b. To maintain sufficient battery level, the device will automatically begin recharging when the battery falls below 50%. If the charging dock isn't detected, the app will remind you to drive the device closer to the dock.
- c. The 'PumPlus' app will notify you to recharge at 50% and 20% battery levels.
- d. Signals from other charging docks (e.g., a robotic vacuum) can interfere with the recharging efficiency. It's recommended to keep at least a 2-meter distance between different charging docks for better results.

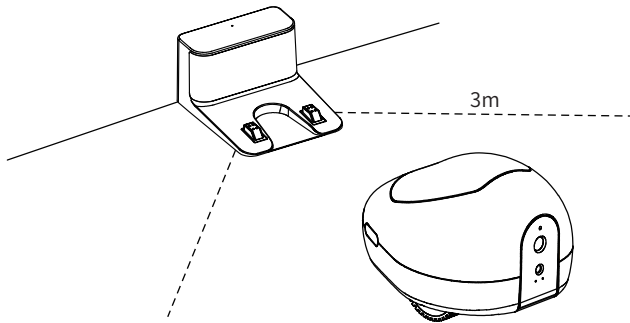

9. Impressive Maneuverability

- a. The device can easily climb carpets up to 1.5 cm thick, meaning that common household rugs won't hinder their movement. This allows it to navigate your home effortlessly, making interactions with your pet smoother and more enjoyable.



- b. The durable, high-torque brushless motor provides powerful support, enabling the device to effortlessly climb slopes up to 15 degrees and easily adapt to sloped areas in the home.

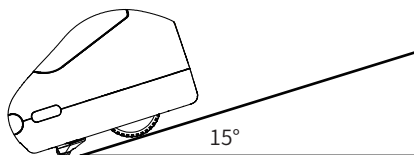

10. Anti-Drop Protection

The device features four anti-drop sensors that detect steps over 2 inches to prevent falls near stairs. However, it may get stuck on slippery metal tracks or misjudge strong light reflections, causing it to stop. Users can steer it away manually or disable the 'anti-fall' feature in the app.

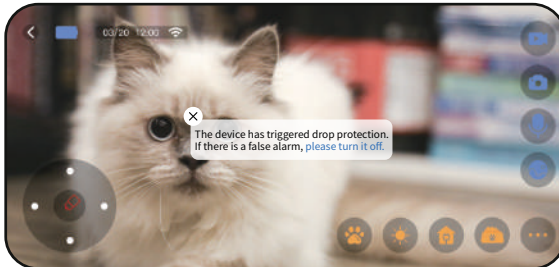
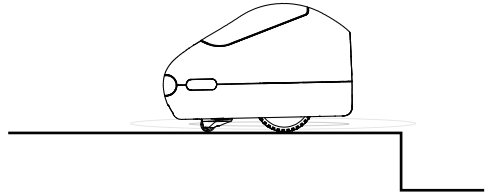
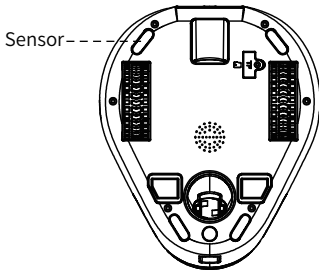

11. Pair Multiple Devices

Tap the '+' icon on the home page to add a device, then follow step 3 or 4 to complete the pairing process.

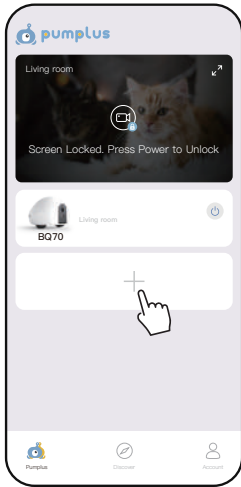

12. Discover

The device captures videos and photos that can be saved to your photo album for easy sharing with family and friends.

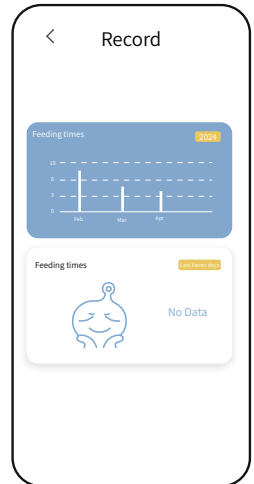
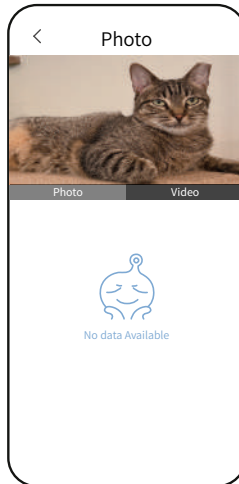
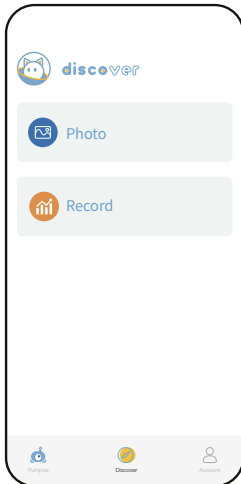

13. Add Friends and share

On your 'Account' page, tap 'Friends list' and search for their email addresses to add them to your friend list.

Note: Please ensure that your friend has downloaded and registered with 'PumPlus'.

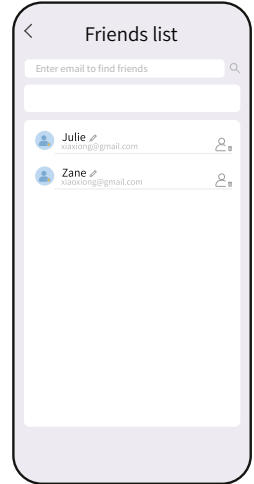
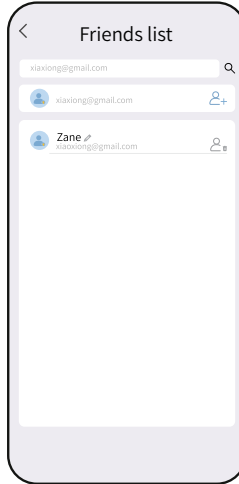
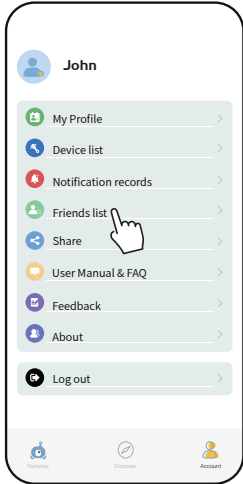

After adding a friend, on your 'Account' page, click 'Share' to grant device permissions to the friend.

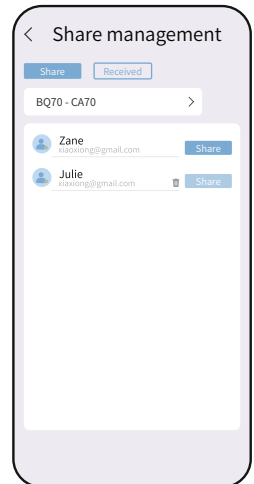
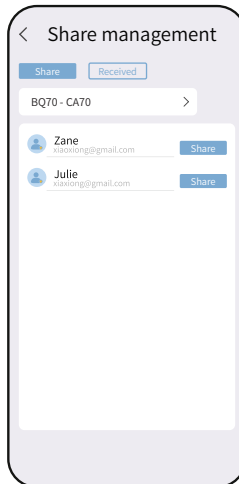
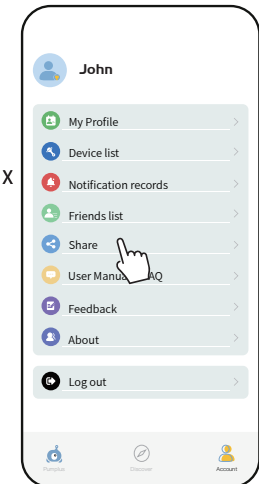

After successfully sharing, please confirm with your friend if the sharing was successful. You can delete the sharing when you don't want to share.

14. User Manual & FAQ

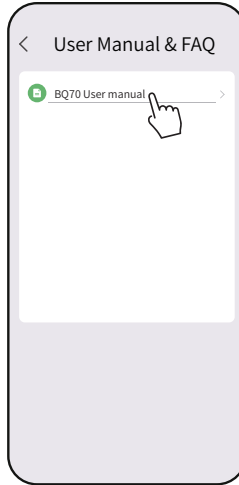
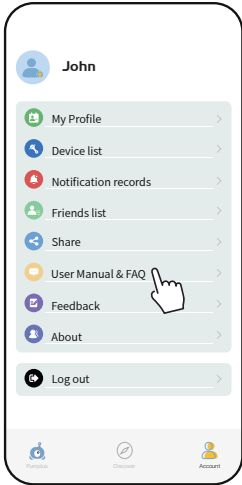

15. Feedback

Contact us anytime if you encounter any issues or have suggestions.

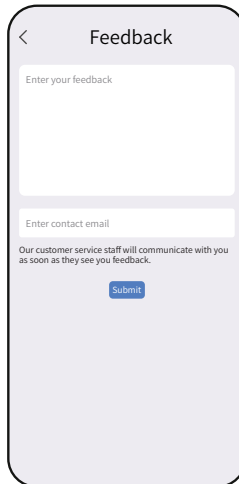
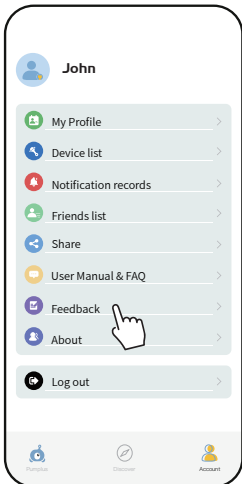

16. About

For software upgrades and any other issues, please contact us.

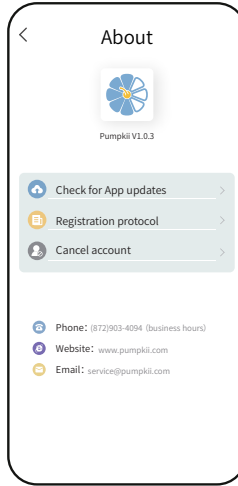
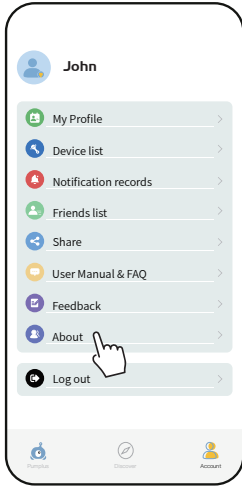

17. Firmware Update and Unpair

To upgrade the firmware, click on 'Account' to access the 'Device List', then click the 'Upgrade' button next to the device (the blue 'Upgrade' button will be clickable).

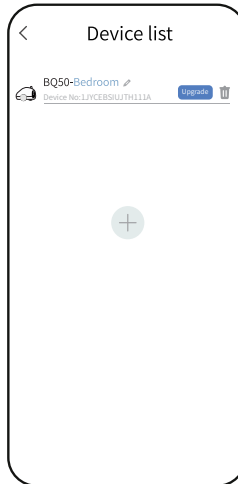
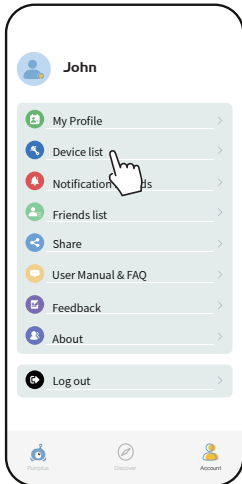

To unbind a device, click on 'Account' to access the 'Device List', then click the '🗑️' icon next to the device. Confirm the unbinding by clicking 'OK' in the warning prompt.

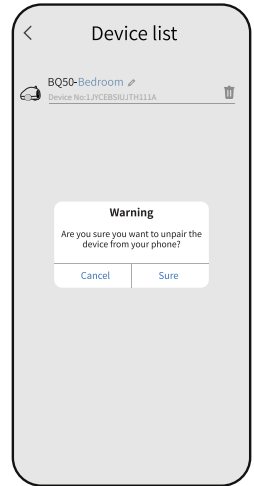
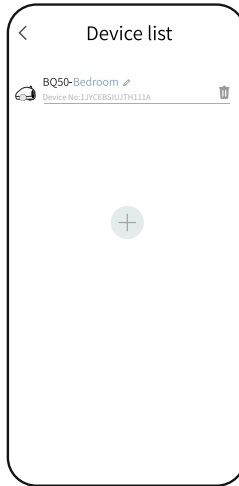
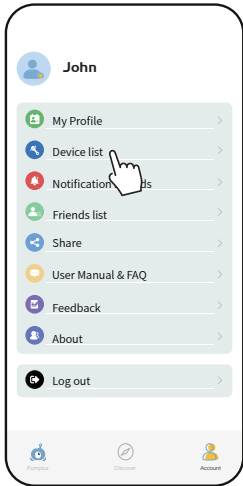

18. Restore Factory settings

Hold down the switch located on the bottom for 10 seconds until you hear the 'restore factory setting, don't power off' sound prompt. This will allow you to reconnect your device again.

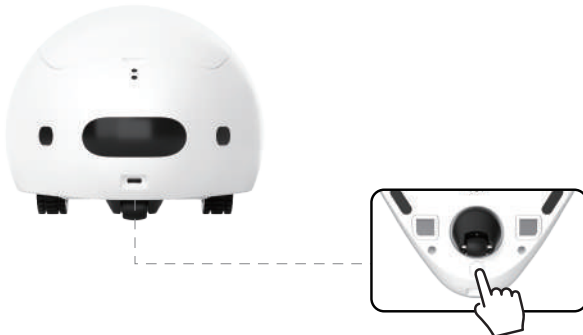

2.4G Wi-Fi Compatibility: The device is compatible with 2.4GHz Wi-Fi. With a regular single router, you can usually see two IDs, 2.4G and 5G. Connect to the 2.4G network. Most mesh routers are compatible with 2.4G, although some may require splitting the 2.4G and 5G networks.

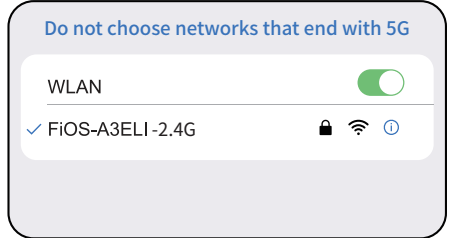
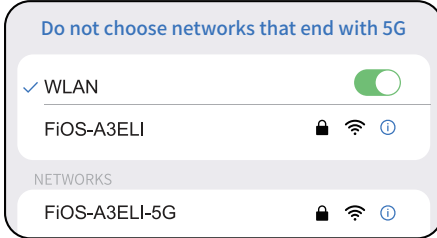

Device Access: Grant the device access to Local Network, Camera, and other necessary features. Enable Wireless Data usage for both Wi-Fi and Cellular Data connections.

